

PROJECT: 3711.3.15



# PROPOSED HIGHWAY LANDSCAPE DEVELOPMENT PROJECT



T.I.P. #	STATE PROJECT W.B.S. #	SHEET #	SHEET # TOTAL
	3711.3.15	L01	13
FED. PROJ. #	DESCRIPTION		DIVISION
XXX-00-0(000)000	Landscape Planting Hardscape Improvements		11

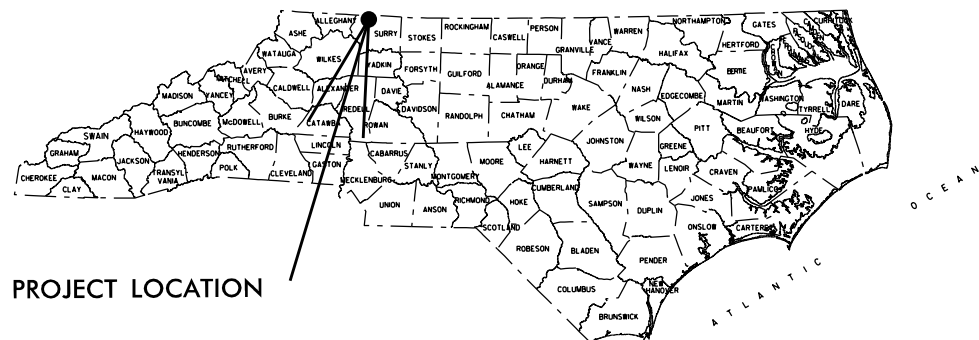

PROJECT LOCATION

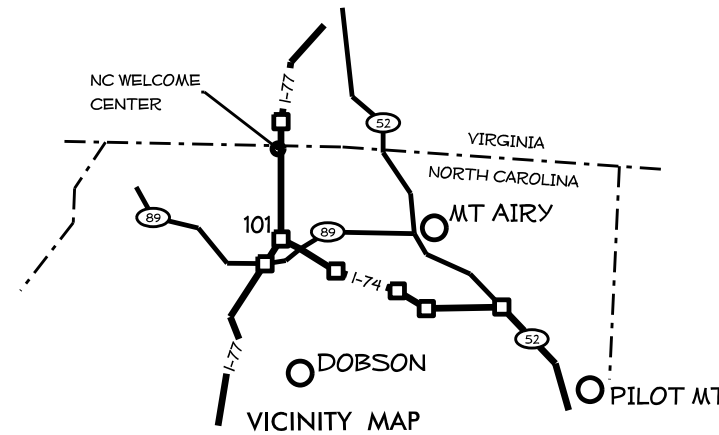

VICINITY MAP

### CONVENTIONAL SYMBOLS

County Line	-----
City or Town Line	-----
Exist. Right of Way Line Marker	-----▲-----
Prop. Right of Way Line Marker	-----▲-----
(By Others)	-----▲-----
Prop Right of Way Line Marker	-----▲-----
(By Contract)	-----▲-----
Exist. Control of Access Line	-----○-----
Prop. Control of Access Line	-----○-----
Property Line	-----○-----
Easement Line	-----○-----
Slope Stake Line	-----○-----
Exist. Fence	-----○-----
Prop. Woven Wire Fence	-----○-----
Prop. Chain Link Fence	-----○-----
Exist. Road	-----○-----
Prop. Road	-----○-----
Guardrail	-----○-----
Survey Line	-----○-----
Denotes Line Equality	-----○-----
Bridge	-----○-----
Culvert	-----○-----
Railroad	-----○-----
Woods	-----○-----
Exist. Telephone Pole	-----○-----
Prop. Telephone Pole	-----○-----
Tower Pole and Line	-----○-----
Exist. Power Pole	-----○-----
Prop. Power Pole	-----○-----
Sanitary Sewer Line	-----○-----
Water Line	-----○-----
Gas Line	-----○-----
Picnic Shelter	-----○-----
Regeneration	-----○-----
Reforestation	-----○-----

SUMMARY OF QUANTITIES											
Des	Sec	Qty	Unit	Key	Botanical Name	Common Name	Size	Caliper	Furnish	A.S.N.S.	Remarks
L	1670	23	EA	AN	<i>Athyrium nipponicum 'Pictum'</i>	Japanese Painted Fern			#1 cont.	12.3	
L	1670	10	EA	AE1	<i>Azalea x 'Conita' PP#10438</i>	Autumn Rouge Encore Azalea	12-15"		#1 cont.	4.2.2	
L	1670	12	EA	AE2	<i>Azalea x 'Roblem' PP#15043</i>	Autumn Starlight Encore Azalea	12-15"		#1 cont.	4.2.2	
L	1670	18	EA	AG	<i>Abelia grandiflora 'Kaleidoscope'</i>	Kaleidoscope Abelia	15-18"		#3 cont.	4.2.4	
L	1670	11	EA	AG	<i>Abelia grandiflora 'Little Richard'</i>	Little Richard Abelia	15-18"		#3 cont.	4.2.4	
L	1670	3	EA	BD	<i>Buddleia davidii 'Purple Haze'</i>	Purple Haze Butterfly Bush	15-18"		#3 cont.	4.2.4	
L	1670	8	EA	CF	<i>Coronilla florida</i>	Flowering Dogwood	6-7"		#7 cont.	1.3	
L	1670	11	EA	EP	<i>Echinacea purpurea</i>	Purple Coneflower			#1 cont.	12.3	
L	1670	15	EA	FG	<i>Fothergilla gardenii</i>	Dwarf Fothergill	15-18"		#3 cont.	2.2.2	
L	1670	2	EA	GKH	<i>Gardenia 'Klein's Hardy'</i>	Klein's Hardy Gardenia	18-24"		#3 cont.	4.2.4	
L	1670	2125	EA	HRP	<i>Hemerocallis 'Buttered Popcorn'</i>	Buttered Popcorn Daylily			#1 cont.	12.2.3	30" o.c.
L	1670	23	EA	HBH	<i>Hosta 'Blue Umbrella'</i>	Blue Umbrella Hosta			#1 cont.	12.2.4	
L	1670	28	EA	HII	<i>Helleborus niger</i>	Christmas Rose			#1 cont.	12.3	
L	1670	4	EA	IG	<i>Ilex glabra 'Shamrock'</i>	Shamrock Inkberry Holly	18-24"		#3 cont.	4.2.4	
L	1670	3	EA	IVH	<i>Itea virginiana 'Henry's Garnet'</i>	Henry's Garnet Virginia Sweetspire	15-18"		#3 cont.	2.2.2	
L	1670	8	EA	DVI	<i>Ilex verticillata 'Red Sprite'</i>	Red Sprite Deciduous Holly	15-18"		#3 cont.	2.2.2	
L	1670	1	EA	IVS	<i>Ilex verticillata 'Jim Dandy'</i>	Jim Dandy Holly	15-18"		#3 cont.	2.2.2	
L	1670	7	EA	JVG	<i>Juniperus virginiana 'Grey Owl'</i>	Grey Owl Juniper			#3 cont.	3.2.3	Field Staked
L	1670	25	EA	LCH	<i>Lantana c 'Chapel Hill'</i>	Chapel Hill Lantana			#1 cont.	12.3	
L	1670	258	EA	LHB	<i>Liriope muscari 'Big Blue'</i>	Big Blue Liriope			#1 cont.	12.5	15" o.c.
L	1670	1100	EA	LS	<i>Liriope spicata</i>	Creeping Lily Turf			#SP4	12.5	
L	1670	14	EA	JMC	<i>Muhlenbergia capillaris</i>	Pink Muhly Grass			#1 cont.	12.4	
L	1670	16	EA	PHM	<i>Panicum virgatum 'Heavy Metal'</i>	Heavy Metal Switchgrass			#3 cont.	12.4	
L	1670	14	EA	RF	<i>Rudbeckia fulgida 'Goldstrum'</i>	Brown-eyed Susan			#1 cont.	12.3	
L	1670	14	EA	RRK	<i>Rosa radrazz</i>	Red Knockout Rose	15-18"		#2 cont., No. 1 Grade	5.6	
L	1670	7	EA	RU	<i>Raphiolepis umbellata</i>	Minor Yecda Hawthorne	18-24"		#3 cont.	4.2.4	
L	1670	15	EA	SH	<i>Sporobolus heterolepis</i>	Prairie Dropseed			#1 cont.	12.4	
L	1670	100	SY			Pre-emergent Treatment for Plant Beds					
2729	1670	115	CY			Mulch for Planting					
2731	1670	38	H/G			Water for Planting					
SP		1000	LF			Tree Preservation/Protection Fence					
SP		1	IS			Demolition					
SP		4	EA			Selective Tree Removal					
SP		1	IS			Landscape Grading					
SP		50	CY			Topsoil					
SP		1647	SF			Segmental Block Retaining Wall					
SP	848	635	SY			Concrete Paving 4" Concrete Sidewalk					
SP		1	IS			Concrete Pavers and Concrete Paver Edging					
SP		200	LF			Split Rail Fence					
SP		1	IS			Reset Wooden Welcome Sign					
SP		5	EA			Re-Placement of Boulders					
SP		2	EA			Rebate Post Top Light					
SP		100	LF			2" PVC Conduit for Post Top Lights					
SP		5	EA			Electrical Junction Box 12 inch					
SP		1	EA			Rebate Picnic Shelter					
SP		588	LF			Landscape Metal Edging					
SP		3	EA			New Post Top Light					
SP		100	LF			Electric Line - Install / Repair					
L	1670	0.50	Ac			Repair Seeding and Mulching					

### INDEX OF L SHEETS:

- L 1 - TITLE, DESCRIPTION, LOCATION
- L 2 - PLANTING DETAILS
- L 3-5 - PLANTING PLANS
- L 6-14 - HARDSCAPE PLANS and DETAILS

PREPARED BY: dlw DATE: 12/07/11

### REVISIONS

DATE	DESCRIPTION



STATE OF  
**NORTH CAROLINA**  
DEPARTMENT OF TRANSPORTATION

LOCATION: Interstate 77 Surry Welcome Center  
TYPE of WORK: Welcome Center Landscape and Hardscape Renovation  
COUNTY: **SURRY COUNTY**

2012 STANDARD SPECIFICATIONS  
PREPARED IN THE OFFICE OF:  
NCDOT- ROADSIDE ENVIRONMENTAL UNIT  
LANDSCAPE DESIGN & DEVELOPMENT SECTION  
1557 MAIL SERVICE CENTER  
RALEIGH NC 27699 919-707-2920

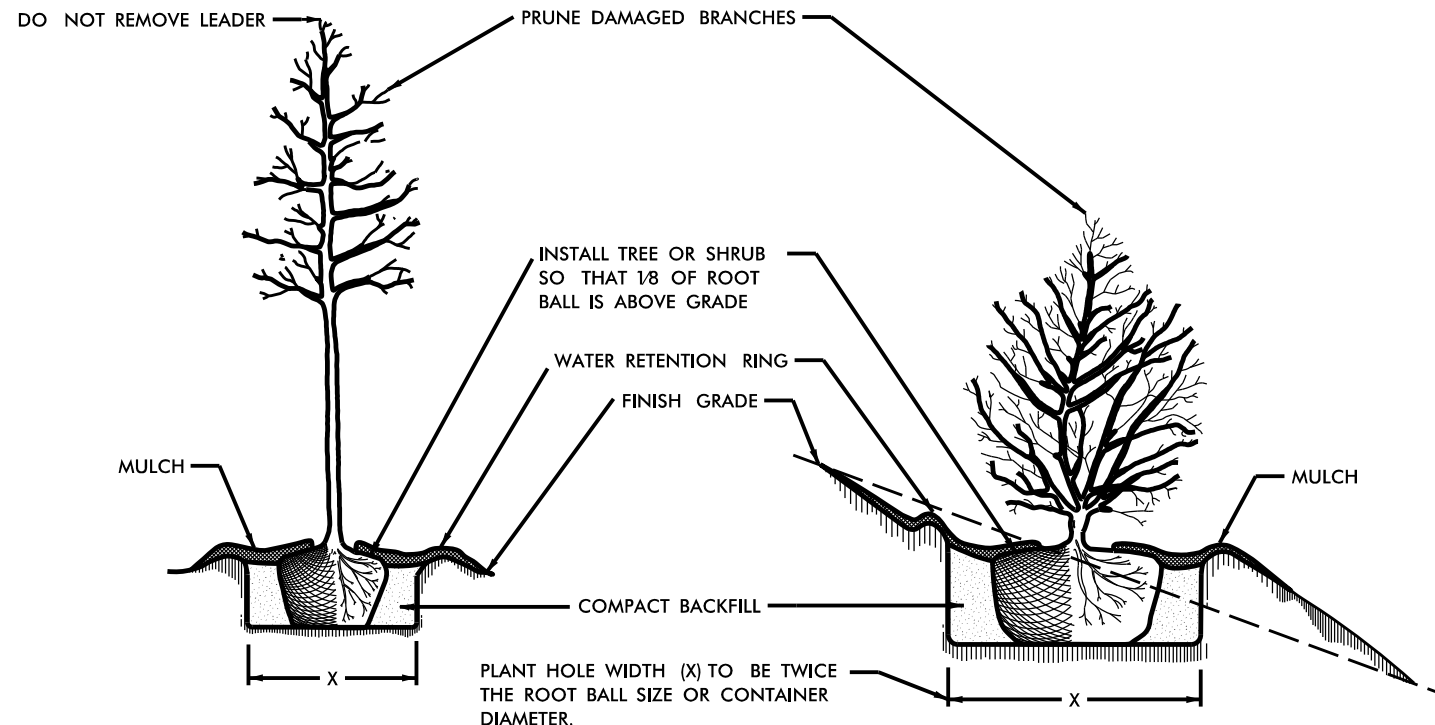

**TREE OR SHRUB PLANTING DETAIL**  
(LEVEL GROUND)

**TREE OR SHRUB PLANTING DETAIL**  
(SLOPING GROUND)

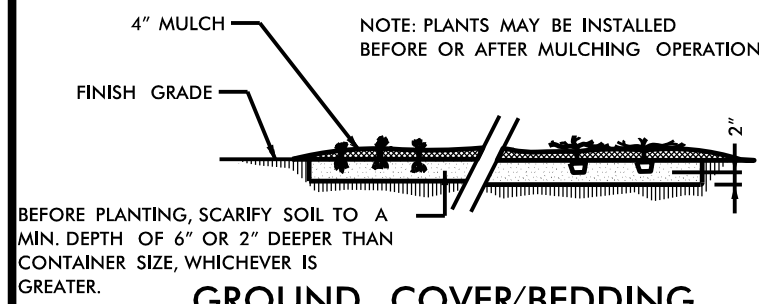

**GROUND COVER/BEDDING PLANT DETAIL**

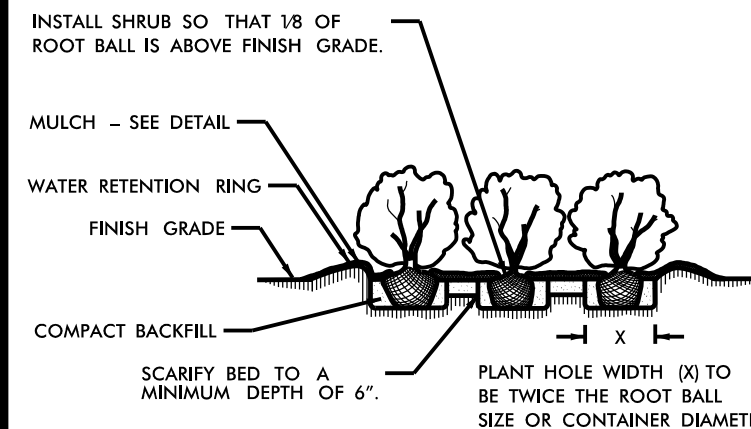

**SHRUB BED PLANTING DETAIL**

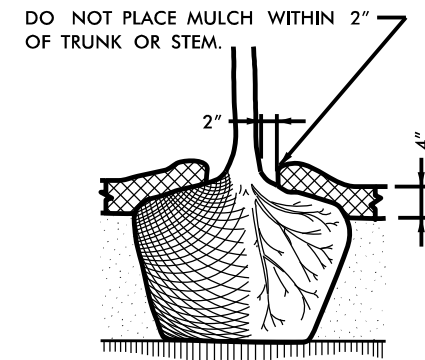

**MULCH DETAIL**

**NOTES:**

- SCHEDULE FOR PLANT HOLE SIZE:  
 PLANT HOLE WIDTH (X) TO BE TWICE THE ROOT BALL SIZE OR CONTAINER DIAMETER.
- SEE STANDARD SPECIFICATIONS FOR PLANT BED FUMIGATION AND HERBICIDAL TREATMENT.
- APPLY FERTILIZER AT PLANTING TIME IN THE FORM OF A SLOW RELEASE PELLET OR TABLET. APPLY AT RATE RECOMMENDED BY MANUFACTURER. BOTH RATE AND FORMULATION MUST BE APPROVED BY FIELD ENGINEER PRIOR TO APPLICATION.
- REMOVE WIRE BASKET AND FOLD BURLAP BACK FROM TOP OF ROOT BALL BEFORE BACKFILLING IS COMPLETE.
- ALL PRUNING TO FOLLOW STANDARD ARBORICULTURAL PRACTICES AS SPECIFIED BY INTERNATIONAL SOCIETY OF ARBORICULTURE.
- DO NOT ATTEMPT TO STRAIGHTEN A TREE THAT HAS BEEN PLANTED AT AN ANGLE WITH THE USE OF STAKING OR GUYING. DIG TREE AND REPLANT TO UPRIGHT POSITION.

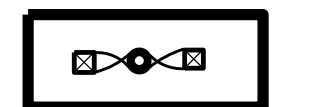
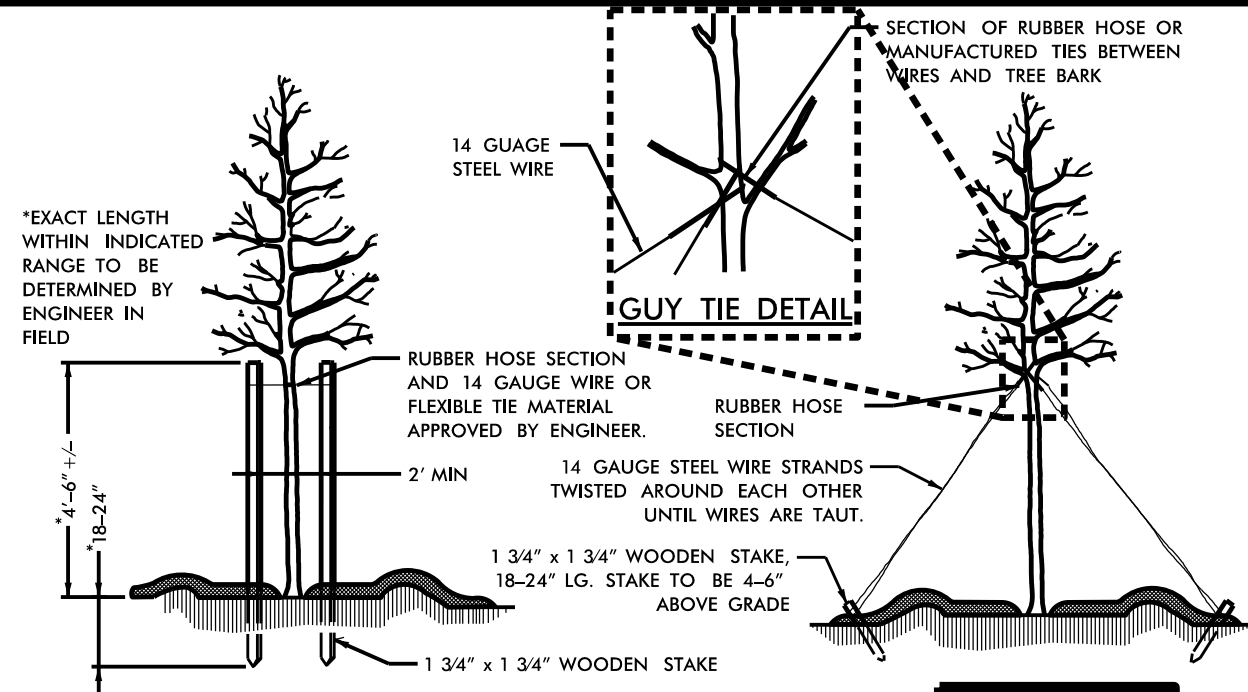

**PLAN VIEW**  
**STAKING DETAIL**  
(TREES 6'-10')

USE AS DIRECTED BY FIELD ENGINEER

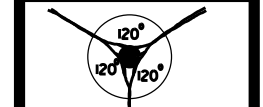
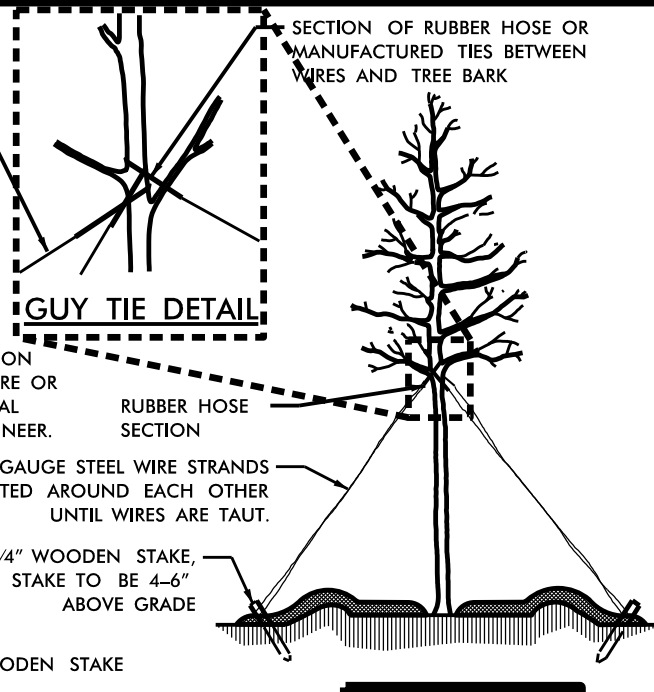

**PLAN VIEW**  
**GUYING DETAIL**  
(TREES 10' OR LARGER)

USE AS DIRECTED BY FIELD ENGINEER

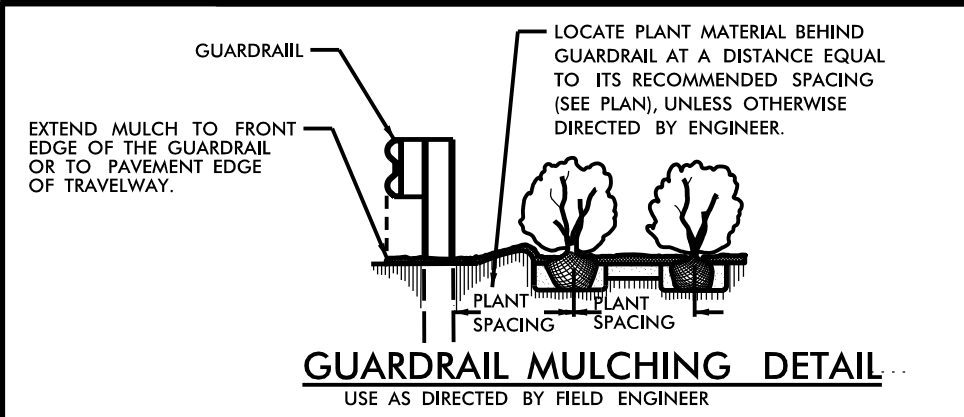

**GUARDRAIL MULCHING DETAIL**  
USE AS DIRECTED BY FIELD ENGINEER

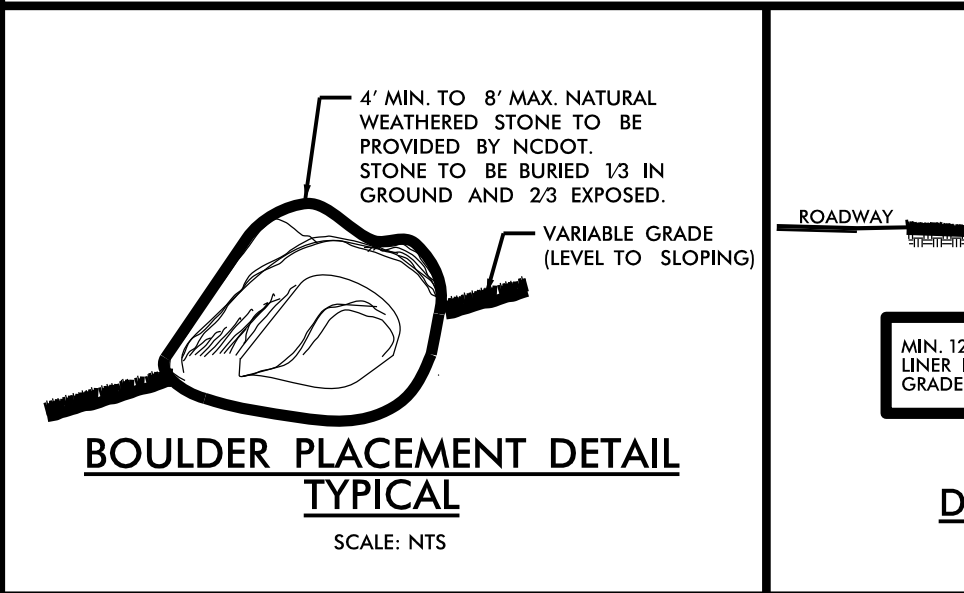

**BOULDER PLACEMENT DETAIL**  
**TYPICAL**

SCALE: NTS



MIN. 12" DEEP CLASS "A" STONE ON FILTER FABRIC LINER IN DITCH. PLACE STONE FLUSH WITH DITCH GRADE FOR MAXIMUM WATER FLOW.

**CLASS "A" STONE DITCH LINING DETAIL**

STATE W.B.S. # 3711.3.15  
I.P. #  
FA #

LANDSCAPE DESIGN & DEVELOPMENT SECTION  
NCDOT ROADSIDE ENVIRONMENTAL UNIT  
1557 MAIL SERVICE CENTER  
RALEIGH NC 27699 919-707-2920

PLAN: **Planting Details**  
PROJECT DESCRIPTION: **Surry Welcome Center Landscape Renovation**

DESIGNED BY: **DLW**  
SHEET: **102**  
DATE: **12/07/2011**  
SCALE: **As Shown**  
SHEET # **102** OF **14**

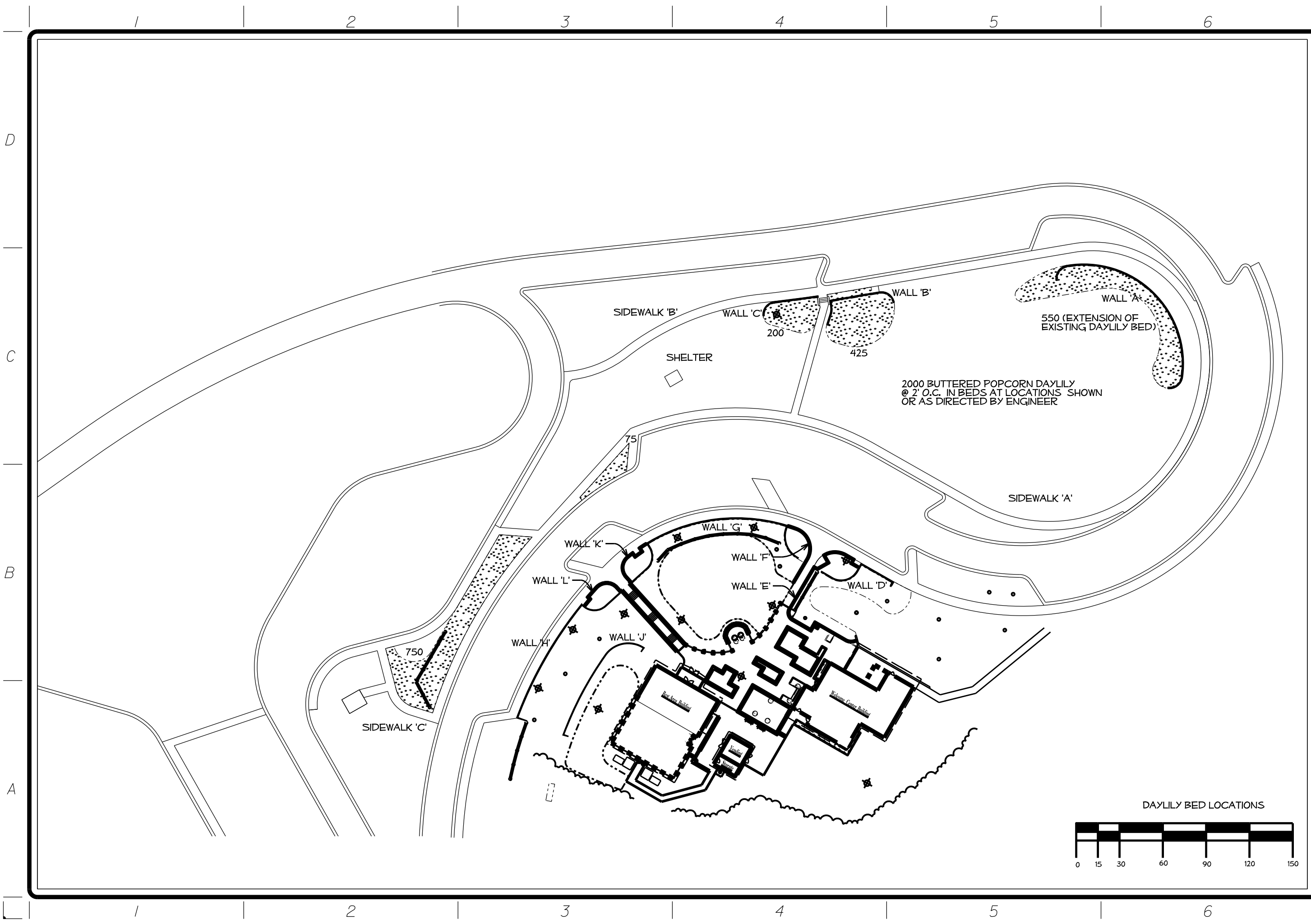

LANDSCAPE DESIGN & DEVELOPMENT SECTION  
 NCDOT ROADSIDE ENVIRONMENTAL UNIT  
 1557 MAIL SERVICE CENTER  
 RALEIGH NC 27699 919-707-2920

PLAN :  
**Daylily Bed Locations**  
 PROJECT DESCRIPTION :  
 Surry Welcome Center Landscape Renovation

DESIGNED BY:  
**DLW**  
 SHEET:  
 DATE  
**12/07/2011**  
 SCALE  
**As Shown**  
 SHEET # OF  
**L03 13**

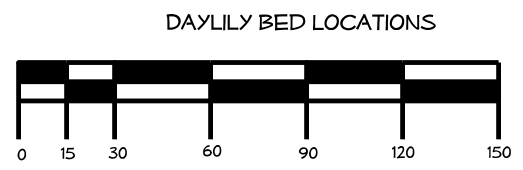

Des	Qty	Unit	Key	Botanical Name	Common Name	Size	Caliper	Furnish	ASNS	Remarks
L 1870	23	EA	AN	<i>Adiantum nipponicum</i> 'Pictum'	Japanese Painted Fern			#1 cont.	12.3	
L 1870	10	EA	AE1	<i>Asiaticum</i> 'Tomato' 'PPF J0478'	Autumn Rouge Encore Azalea	15-18"		#1 cont.	4.2.2	
L 1870	12	EA	AE2	<i>Asiaticum</i> 'Piedmont' 'PPF J0479'	Autumn Starlight Encore Azalea	15-18"		#1 cont.	4.2.2	
L 1870	18	EA	AG	<i>Abelia grandiflora</i> 'Kaleidoscope'	Kaleidoscope Abelia	15-18"		#3 cont.	4.2.4	
L 1870	13	EA	AGL	<i>Abelia grandiflora</i> 'Little Richard'	Little Richard Abelia	15-18"		#3 cont.	4.2.4	
L 1870	3	EA	BD	<i>Buddleia davidii</i> 'Purple Haze'	Purple Haze Butterfly Bush	15-18"		#3 cont.	4.2.4	
L 1870	8	EA	CF	<i>Cornus florida</i>	Flowering Dogwood	6-7'		#1 cont.	1.3	
L 1870	11	EA	EP	<i>Echinacea purpurea</i>	Purple Coneflower			#1 cont.	12.3	
L 1870	15	EA	FG	<i>Fothergilla gardenii</i>	Dwarf Fothergilla	15-18"		#3 cont.	12.2	
L 1870	2	EA	GKH	<i>Gardenia 'Klein's Hardy'</i>	Klein's Hardy Gardenia	18-24"		#3 cont.	4.2.4	
L 1870	2125	EA	HBU	<i>Hebe 'Blue Umbrella'</i>	Buttered Popcorn Daylily			#1 cont.	11.2.3	30" o.c.
L 1870	23	EA	HBU	<i>Hosta 'Blue Umbrella'</i>	Blue Umbrella Hosta			#1 cont.	11.2.4	
L 1870	28	EA	HN	<i>Helleborus niger</i>	Christmas Rose			#1 cont.	12.3	
L 1870	4	EA	IG	<i>Ilex glabra 'Shamrock'</i>	Shamrock Inkberry Holly	18-24"		#3 cont.	4.2.4	
L 1870	9	EA	IVH	<i>Itea virginica 'Henry's Garnet'</i>	Henry's Garnet Itea	15-18"		#3 cont.	12.2	
L 1870	8	EA	IVJ	<i>Ilex verticillata 'Red Sprite'</i>	Red Sprite Deciduous Holly	15-18"		#3 cont.	12.2	
L 1870	1	EA	IVS	<i>Ilex verticillata 'Jim Dandy'</i>	Jim Dandy Holly	15-18"		#3 cont.	12.2	
L 1870	7	EA	JVG	<i>Juniperus virginiana 'Grey Owl'</i>	Grey Owl Juniper	18-24"		#3 cont.	12.3	Field Staked
L 1870	25	EA	LCH	<i>Lantana 'Chapel Hill'</i>	Chapel Hill Lantana			#1 cont.	12.3	
L 1870	258	EA	LMB	<i>Liriodendron 'Big Blue'</i>	Big Blue Liriope			#1 cont.	12.5	15" o.c.
L 1870	1100	EA	LS	<i>Liriodendron 'Creeping Lily'</i>	Creeping Lily Turf			#1 cont.	12.5	
L 1870	14	EA	MC	<i>Muhlenbergia 'Pink Holly'</i>	Pink Holly Grass			#1 cont.	12.4	
L 1870	16	EA	PHM	<i>Phlox paniculata 'Heavy Metal'</i>	Heavy Metal Switchgrass			#1 cont.	12.4	
L 1870	14	EA	RF	<i>Rudbeckia 'Black-eyed Susan'</i>	Black-eyed Susan			#1 cont.	12.3	
L 1870	14	EA	RRK	<i>Rosa 'Red Knockout'</i>	Red Knockout Rose	15-18"		#1 cont. No. 1 Grade	5.6	
L 1870	7	EA	RU	<i>Rosa 'Minor Yedda'</i>	Minor Yedda Hawthorne	18-24"		#3 cont.	4.2.4	
L 1870	15	EA	SH	<i>Solidago 'Prairie Dropseed'</i>	Prairie Dropseed			#1 cont.	12.4	

D  
C  
B  
A

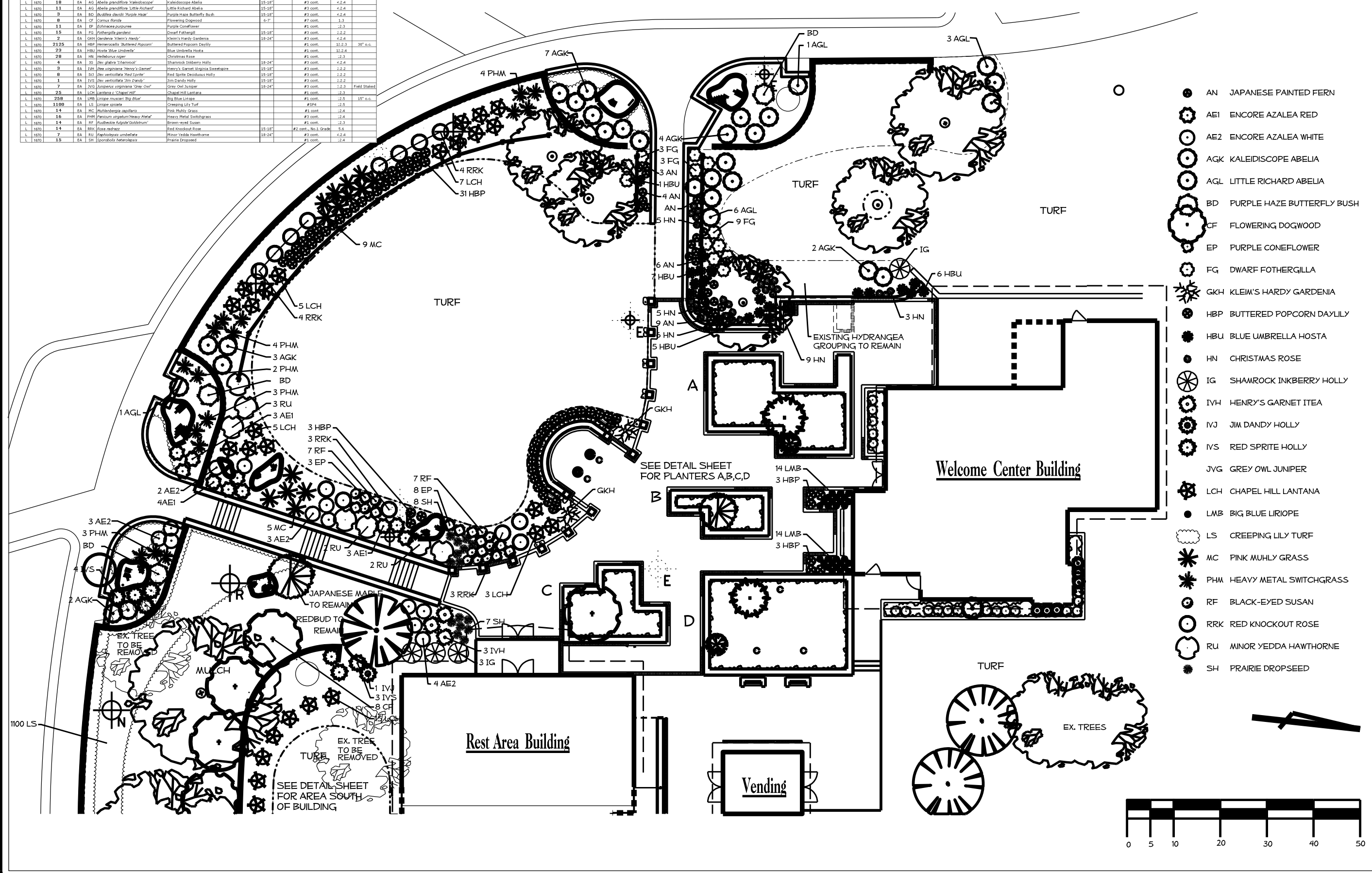

- AN JAPANESE PAINTED FERN
- AE1 ENCORE AZALEA RED
- AE2 ENCORE AZALEA WHITE
- AGK KALEIDOSCOPE ABELIA
- AGL LITTLE RICHARD ABELIA
- BD PURPLE HAZE BUTTERFLY BUSH
- CF FLOWERING DOGWOOD
- EP PURPLE CONEFLOWER
- FG DWARF FOTHERGILLA
- GKH KLEIM'S HARDY GARDENIA
- HBP BUTTERED POPCORN DAYLILY
- HBU BLUE UMBRELLA HOSTA
- HN CHRISTMAS ROSE
- IG SHAMROCK INKBERRY HOLLY
- IVH HENRY'S GARNET ITEA
- IVJ JIM DANDY HOLLY
- IVS RED SPRITE HOLLY
- JVG GREY OWL JUNIPER
- LCH CHAPEL HILL LANTANA
- LMB BIG BLUE LIRIOPE
- LS CREEPING LILY TURF
- MC PINK MUHLY GRASS
- PHM HEAVY METAL SWITCHGRASS
- RF BLACK-EYED SUSAN
- RRK RED KNOCKOUT ROSE
- RU MINOR YEDDA HAWTHORNE
- SH PRAIRIE DROPSIDE

Des	Sec	Qty	Unit	Key	Botanical Name	Common Name	Size	Caliper	Furnish	ASNS	Remarks
L	1820	23	EA	AM	<i>Athyrium niponicum 'Pictum'</i>	Japanese Painted Fern			#1 cont.	12.3	
L	1820	10	EA	AE1	<i>Asplenium 'Conkley' PPM J0478</i>	Autumn Rouge Encore Asplenium	12-15"		#1 cont.	4.2.2	
L	1820	12	EA	AE2	<i>Asplenium 'Redwing' PPM J0479</i>	Autumn Starlight Encore Asplenium	12-15"		#3 cont.	4.2.2	
L	1820	18	EA	AG	<i>Asplenium grandifolium 'Kaleidoscope'</i>	Kaleidoscope Asplenium	12-18"		#3 cont.	4.2.4	
L	1820	11	EA	AG	<i>Asplenium grandifolium 'Little Richard'</i>	Little Richard Asplenium	12-18"		#3 cont.	4.2.4	
L	1820	3	EA	BD	<i>Buddleia davidii 'Purple Heart'</i>	Purple Heart Butterfly Bush	12-18"		#3 cont.	4.2.4	
L	1820	8	EA	CF	<i>Cornus 'Riverside'</i>	Flamingo Dogwood	6-7"		#3 cont.	1.3	
L	1820	11	EA	EP	<i>Colobryne purpurea</i>	Purple Coneflower			#1 cont.	12.3	
L	1820	15	EA	FG	<i>Fothergilla gardenii</i>	Dwarf Fothergill	12-18"		#3 cont.	12.2	
L	1820	2	EA	GM	<i>Gardenia 'Klein's Hardy'</i>	Klein's Hardy Gardenia	18-24"		#3 cont.	4.2.4	
L	1820	2125	EA	HBP	<i>Hebe 'Emerald' 'Buttered Popcorn'</i>	Buttered Popcorn Daylily			#1 cont.	12.2.3	30" o.c.
L	1820	23	EA	HBU	<i>Hosta 'Blue Umbrella'</i>	Blue Umbrella Hosta			#1 cont.	12.2.4	
L	1820	28	EA	HN	<i>Helleborus niger</i>	Christmas Rose			#1 cont.	12.3	
L	1820	4	EA	IS	<i>Ilex glabra 'Shamrock'</i>	Shamrock Inkberry Holly	18-24"		#3 cont.	4.2.4	
L	1820	3	EA	IS	<i>Ilex virginiana 'Henry's Garnet'</i>	Henry's Garnet Virginia Wintergreen	12-18"		#3 cont.	12.2	
L	1820	8	EA	ISV	<i>Ilex verticillata 'Red Sprite'</i>	Red Sprite Deciduous Holly	12-18"		#3 cont.	12.2	
L	1820	1	EA	ISV	<i>Ilex verticillata 'Jim Dandy'</i>	Jim Dandy Holly	12-18"		#3 cont.	12.2	
L	1820	7	EA	JYG	<i>Juniperus virginiana 'Green Owl'</i>	Green Owl Juniper	18-24"		#3 cont.	12.3	Field Staked
L	1820	25	EA	LCN	<i>Liriodendron 'Shaggy Red'</i>	Shaggy Red Liriodendron			#1 cont.	12.3	
L	1820	258	EA	LMB	<i>Liriodendron 'Big Blue'</i>	Big Blue Liriodendron			#1 cont.	12.5	15" o.c.
L	1820	1100	EA	LS	<i>Liriodendron 'Creeping Lily'</i>	Creeping Lily Turf			#SP4	12.5	
L	1820	14	EA	MC	<i>Muhlenbergia 'Mistral'</i>	Mistral Grass			#3 cont.	12.4	
L	1820	16	EA	MB	<i>Muhlenbergia 'Henry's Star'</i>	Henry's Star Switchgrass			#3 cont.	12.4	
L	1820	14	EA	RF	<i>Rudbeckia 'Goldstrum'</i>	Brown-eyed Susan			#1 cont.	12.3	
L	1820	14	EA	RRK	<i>Rosa 'Red Knockout'</i>	Red Knockout Rose	12-18"		#3 cont. No. 1 Grade	5.6	
L	1820	7	EA	RU	<i>Rubus 'Wedge'</i>	Wedge Hawthorne	18-24"		#3 cont.	4.2.4	
L	1820	15	EA	SP	<i>Sporobolus 'Antelope'</i>	Antelope Grass			#3 cont.	12.4	

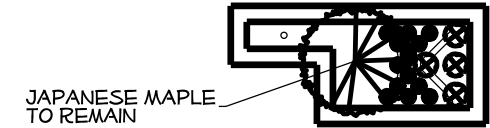
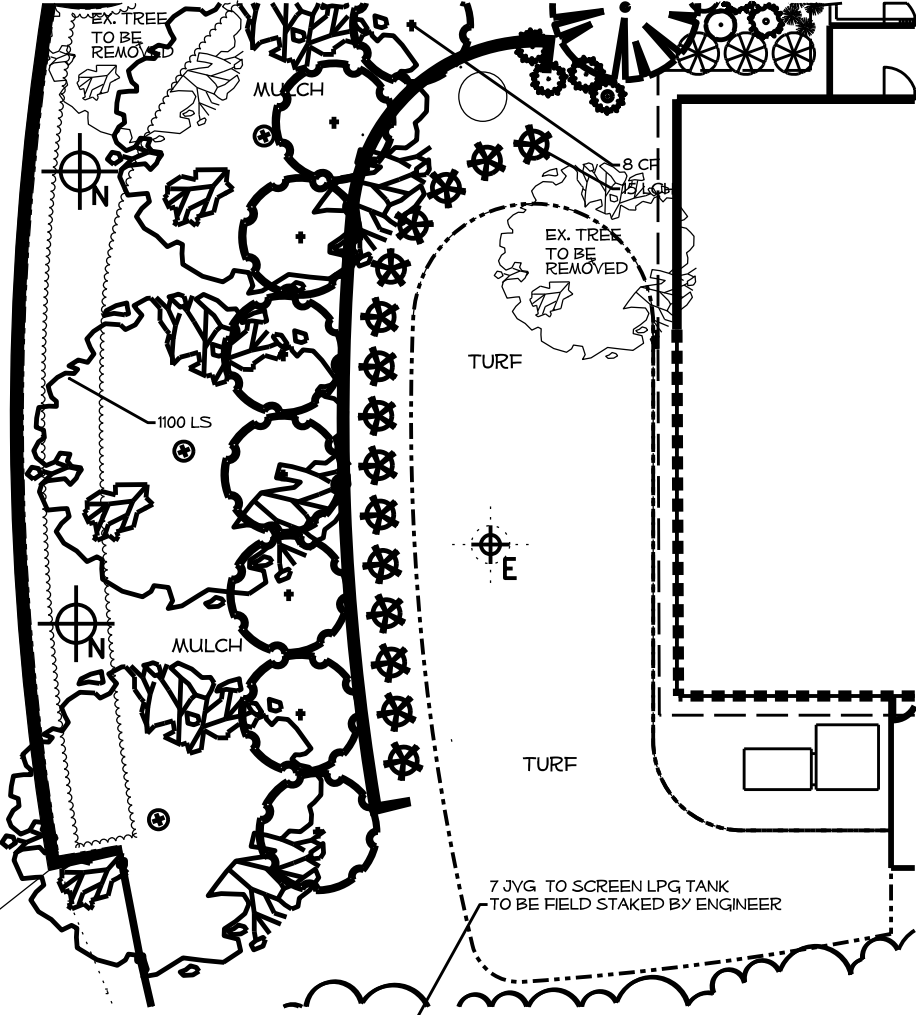

Planter B

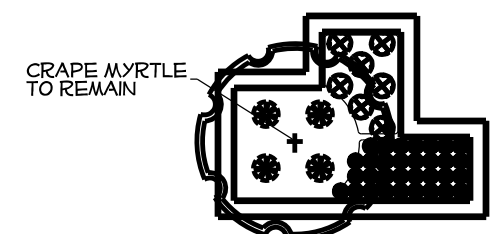

Planter C

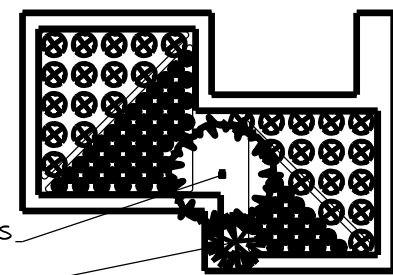

Planter A

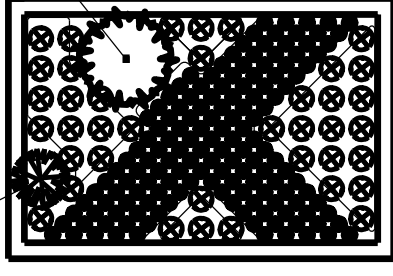

Planter D

4 HBP BUTTERED POPCORN DAYLILY  
13 LMB BIG BLUE LIRIOPE

7 HBP BUTTERED POPCORN DAYLILY  
4 HBU BLUE UMBRELLA HOSTA  
32 LMB BIG BLUE LIRIOPE

15 HBP BUTTERED POPCORN DAYLILY  
44 LMB BIG BLUE LIRIOPE

15 HBP BUTTERED POPCORN DAYLILY  
19 LMB BIG BLUE LIRIOPE

GOLD MOP FALSECYPRESS TO REMAIN

GOLD MOP FALSECYPRESS TO REMAIN  
15 HBP BUTTERED POPCORN DAYLILY

4 HBP BUTTERED POPCORN DAYLILY

16 HBP BUTTERED POPCORN DAYLILY  
150 LMB BIG BLUE LIRIOPE

BIRD'S NEST SPRUCE TO REMAIN

4 HBP BUTTERED POPCORN DAYLILY

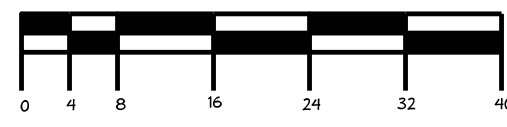

WALL SCHEDULE	NOMINAL HEIGHT	NOMINAL LENGTH	ELEVATION NOTES
'A'	30-32"	158'	FINISHED GRADE BASE OF WALL = 0.5' ABOVE TOP OF CURB
'B'	18-24"	67'	FINISHED GRADE TOP OF WALL = TOP OF CHEEK WALL + 8-12"
'C'	12-16"	45'	FINISHED GRADE TOP OF WALL = TOP OF CHEEK WALL
'D'	16-18"	70'	FINISHED GRADE BASE OF WALL = ADJACENT SIDEWALK
'E'	6-8"	124'	FINISHED GRADE BASE OF WALL = ADJACENT SIDEWALK/PATIO
'F'	6-8"	50'	FINISHED GRADE BASE OF WALL = ADJACENT SIDEWALK
'G'	16-18"	168'	FINISHED GRADE BASE OF WALL = ADJACENT SIDEWALK
'H'	30-32"	132'	FINISHED GRADE BASE OF WALL = ADJACENT SIDEWALK
'J'	16-18"	100'	FINISHED GRADE TOP OF WALL = FINISHED FLOOR BUILDING - 12"
'K'	6-8"	43'	FINISHED GRADE BASE OF WALL = ADJACENT SIDEWALK
'L'	6-8"	38'	FINISHED GRADE BASE OF WALL = ADJACENT SIDEWALK

\*NOMINAL HEIGHT IS FROM FINISHED GRADE AT BASE OF EXPOSED SIDE TO TOP OF WALL EXCLUDING CAPSTONE. STEP HORIZONTAL WALL COURSING TO MAINTAIN NOMINAL HEIGHT EXCEPT AT WALL END RETURNS. DEVIATIONS FROM THE SHOWN WALL LINES AND ELEVATIONS DUE TO ADVERSE SITE CONDITIONS OR PRODUCT SPECIFICATIONS, SHALL BE APPROVED BY THE ENGINEER.

D  
C  
B  
A

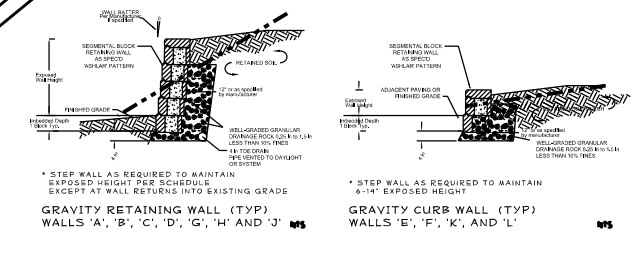
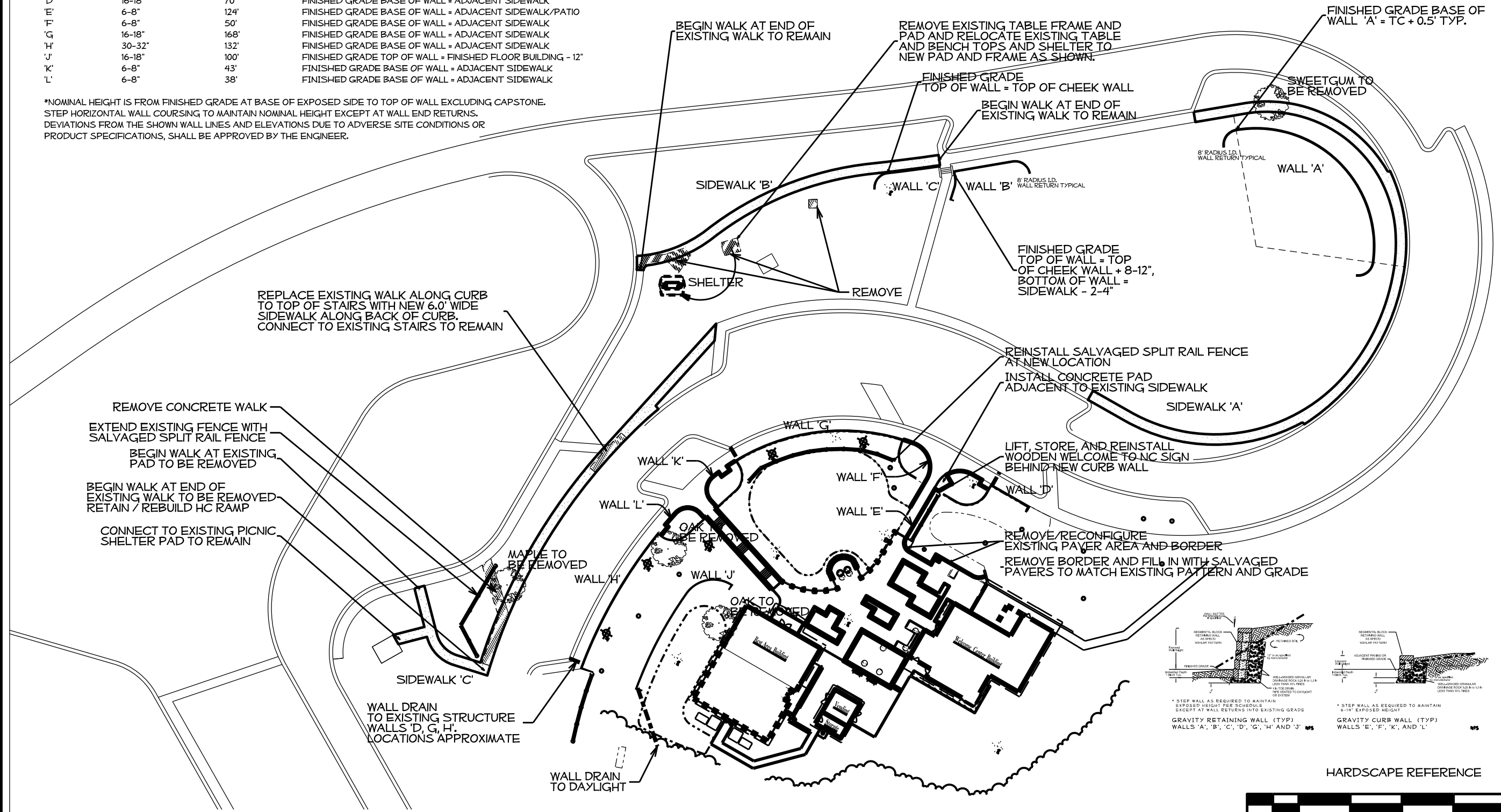

HARDSCAPE REFERENCE

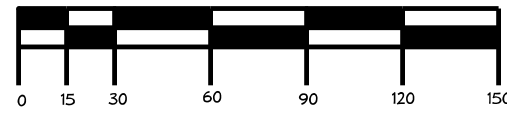

GRADE AREA DISTURBED  
BY NEW AND REMOVED  
SIDEWALK CONSTRUCTION TO  
DRAIN AND BLEND WITH  
SURROUNDING TURF AREAS

FINISHED GRADE BASE OF  
WALL 'A' = TC + 0.5' TYP.

SWEETGUM TO  
BE REMOVED

WALL DRAIN  
THROUGH CURB

8' RADIUS I.D.  
WALL RETURN TYPICAL

WALL 'A'

D  
C  
B  
A

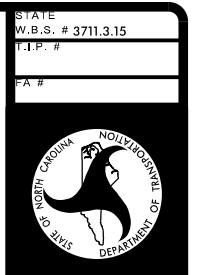
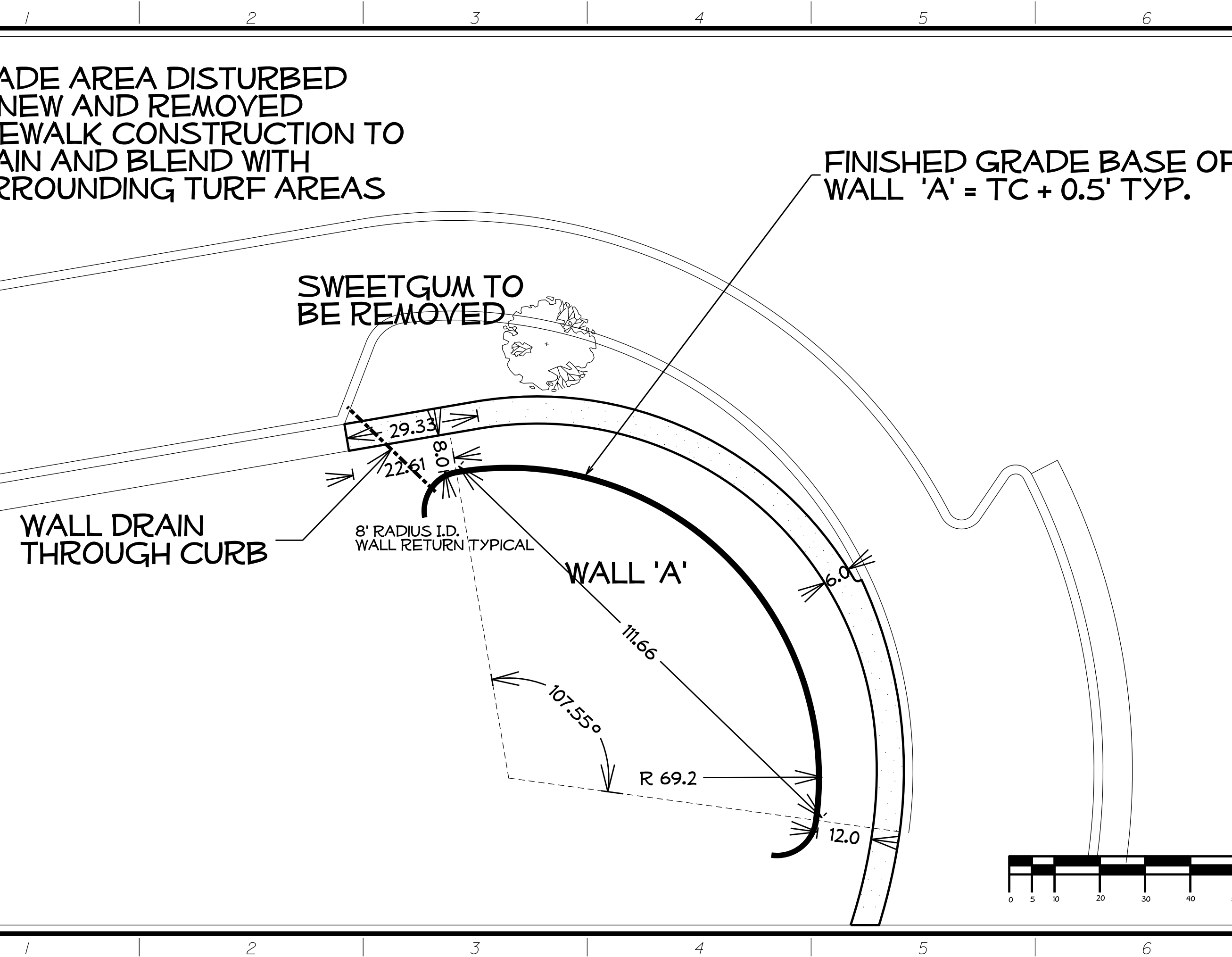

STATE  
W.B.S. # 3711.3.15  
T.I.P. #  
FA #  
LANDSCAPE DESIGN & DEVELOPMENT SECTION  
NCDOT ROADSIDE ENVIRONMENTAL UNIT  
1557 MAIL SERVICE CENTER  
RALEIGH NC 27699 919-707-2920

PLAN :  
Wall 'A'; Sidewalk 'A'  
PROJECT DESCRIPTION :  
Surry Welcome Center Landscape Renovation

DESIGNED BY:  
DLW  
SHEET:  
DATE  
12/07/2011  
SCALE  
As Shown  
SHEET # OF  
L07 14

GRADE AREA DISTURBED BY NEW AND REMOVED SIDEWALK CONSTRUCTION TO DRAIN AND BLEND WITH SURROUNDING TURF AREAS

REMOVE EXISTING TABLE FRAME AND PAD AND RELOCATE EXISTING TABLE AND BENCH TOPS AND SHELTER TO NEW PAD AND FRAME AS SHOWN.

BEGIN WALK AT END OF EXISTING WALK TO REMAIN

FINISHED GRADE TOP OF WALL = TOP OF CHEEK WALL

BEGIN WALK AT END OF EXISTING WALK TO REMAIN

SIDEWALK 'B'

6.0' TYP.

WALL 'C'

WALL 'B' 8' RADIUS I.D. WALL RETURN TYPICAL

WALL DRAIN TO DAYLIGHT

WALL DRAIN THROUGH CURB

FINISHED GRADE TOP OF WALL = TOP OF CHEEK WALL + 8-12", BOTTOM OF WALL = SIDEWALK - 2-4"

SHELTER

REMOVE

SIDEWALK 'C'

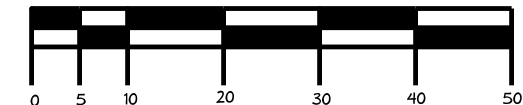

STATE W.B.S. # 3711.3.15

T.I.P. #

PA #



LANDSCAPE DESIGN & DEVELOPMENT SECTION  
 NCDOT ROADSIDE ENVIRONMENTAL UNIT  
 1557 MAIL SERVICE CENTER  
 RALEIGH NC 27699 919-707-2920

PLAN : Walls 'B' and 'C'; Sidewalks 'B' and 'C'; Shelter Relocation

PROJECT DESCRIPTION : Surry Welcome Center Landscape Renovation

DESIGNED BY:

DLW

SHEET:

DATE

12/07/2011

SCALE

As Shown

SHEET # OF

L08 14



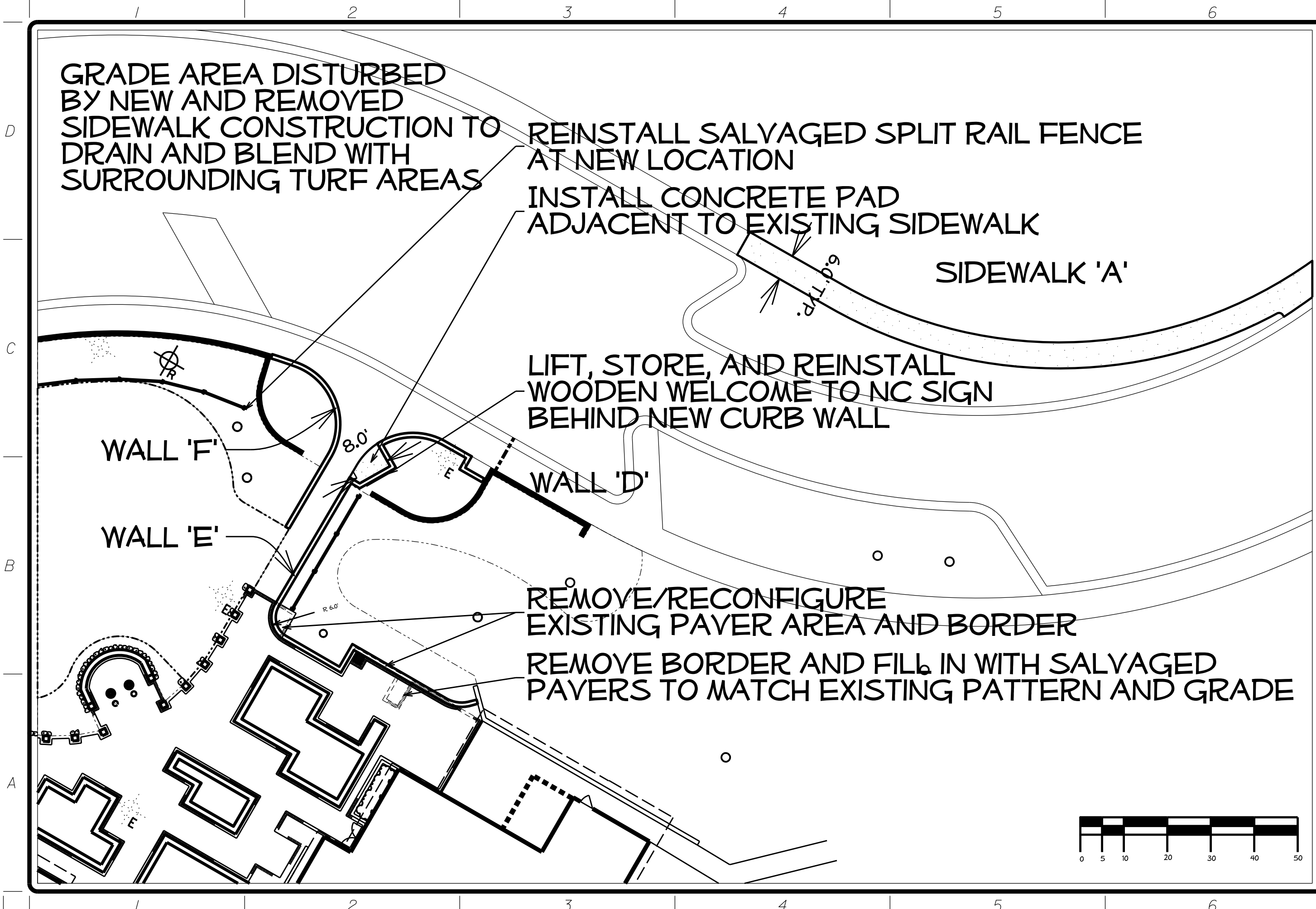

GRADE AREA DISTURBED  
BY NEW AND REMOVED  
SIDEWALK CONSTRUCTION TO  
DRAIN AND BLEND WITH  
SURROUNDING TURF AREAS

REINSTALL SALVAGED SPLIT RAIL FENCE  
AT NEW LOCATION

INSTALL CONCRETE PAD  
ADJACENT TO EXISTING SIDEWALK

SIDEWALK 'A'

LIFT, STORE, AND REINSTALL  
WOODEN WELCOME TO NC SIGN  
BEHIND NEW CURB WALL

WALL 'F'

WALL 'D'

WALL 'E'

REMOVE/RECONFIGURE  
EXISTING PAYER AREA AND BORDER

REMOVE BORDER AND FILL IN WITH SALVAGED  
PAYERS TO MATCH EXISTING PATTERN AND GRADE

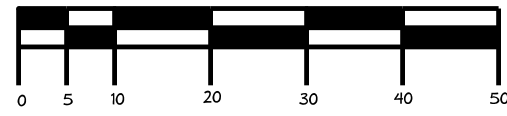

STATE W.B.S. # 3711.3.15 T.I.P. #	
FA #	
LANDSCAPE DESIGN & DEVELOPMENT SECTION NCDOT ROADSIDE ENVIRONMENTAL UNIT 1557 MAIL SERVICE CENTER RALEIGH NC 27699 919-707-2920	
PLAN :	Walls 'D', 'E' and 'F'; Sidewalk 'A'
PROJECT DESCRIPTION :	Surry Welcome Center Landscape Renovation
DESIGNED BY:	DLW
SHEET:	
DATE	12/07/2011
SCALE	As Shown
SHEET #	OF
L09	14

GRADE AREA DISTURBED  
BY NEW AND REMOVED  
SIDEWALK CONSTRUCTION TO  
DRAIN AND BLEND WITH  
SURROUNDING TURF AREAS

D

C

B

A

MAPLE TO  
BE REMOVED

WALL 'H'

35'

WALL 'K'

OAK TO  
BE REMOVED

WALL 'J'

OAK TO  
BE REMOVED

Rest Area Building

WALL 'G'

WALL 'F'

WALL 'E'

R 6.0'

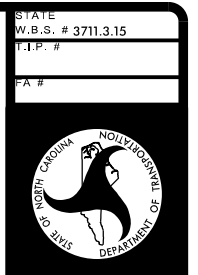
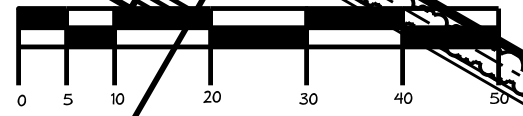

STATE  
W.B.S. # 3711.3.15  
I.P. #  
FA #  
LANDSCAPE DESIGN & DEVELOPMENT SECTION  
NCDOT ROADSIDE ENVIRONMENTAL UNIT  
1557 MAIL SERVICE CENTER  
RALEIGH NC 27699 919-707-2920

PLAN :	
Walls 'G' and 'H'	
PROJECT DESCRIPTION : Surry Welcome Center Landscape Renovation	
DESIGNED BY:	DLW
SHEET:	
DATE:	12/07/2011
SCALE:	As Shown
SHEET #	OF
L10	14

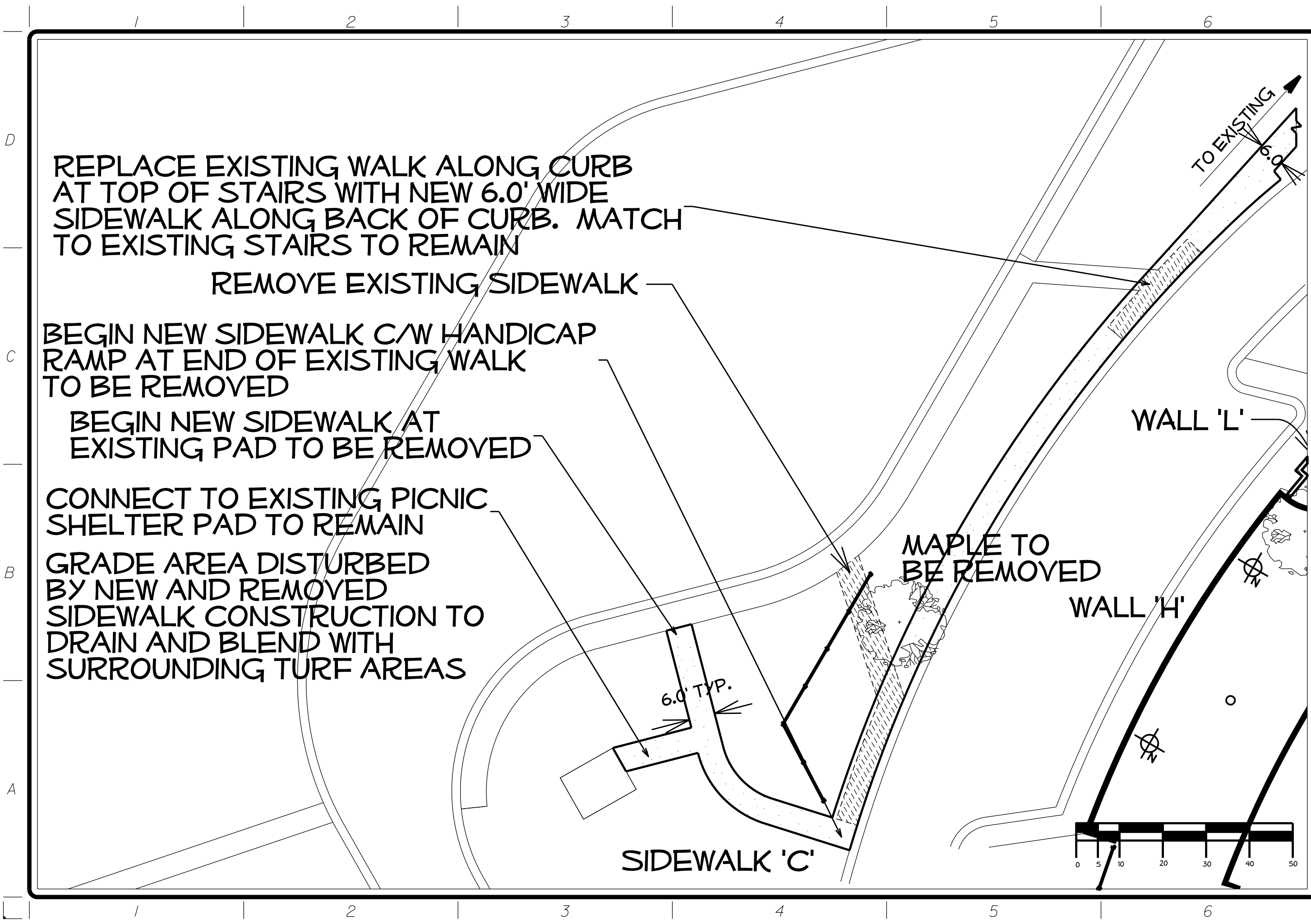

REPLACE EXISTING WALK ALONG CURB  
 AT TOP OF STAIRS WITH NEW 6.0' WIDE  
 SIDEWALK ALONG BACK OF CURB. MATCH  
 TO EXISTING STAIRS TO REMAIN

REMOVE EXISTING SIDEWALK

BEGIN NEW SIDEWALK CW HANDICAP  
 RAMP AT END OF EXISTING WALK  
 TO BE REMOVED

BEGIN NEW SIDEWALK AT  
 EXISTING PAD TO BE REMOVED

CONNECT TO EXISTING PICNIC  
 SHELTER PAD TO REMAIN

GRADE AREA DISTURBED  
 BY NEW AND REMOVED  
 SIDEWALK CONSTRUCTION TO  
 DRAIN AND BLEND WITH  
 SURROUNDING TURF AREAS

SIDEWALK 'C'

MAPLE TO  
 BE REMOVED

WALL 'H'

WALL 'L'

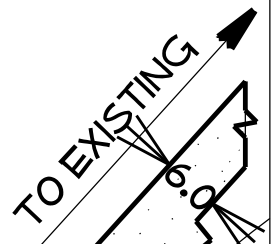

6.0' TYP.

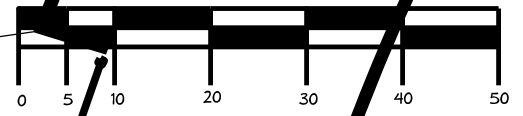

STATE	
W.B.S. # 3711.3.15	
T.I.P. #	
FA #	
	
LANDSCAPE DESIGN & DEVELOPMENT SECTION NCDOT ROADSIDE ENVIRONMENTAL UNIT 1557 MAIL SERVICE CENTER RALEIGH NC 27699 919-707-2920	
PLAN :	Sidewalk 'C'
DESIGNED BY:	DLW
SHEET:	
DATE	12/07/2011
SCALE	As Shown
SHEET #	OF
L11	14

# WALL 'E'

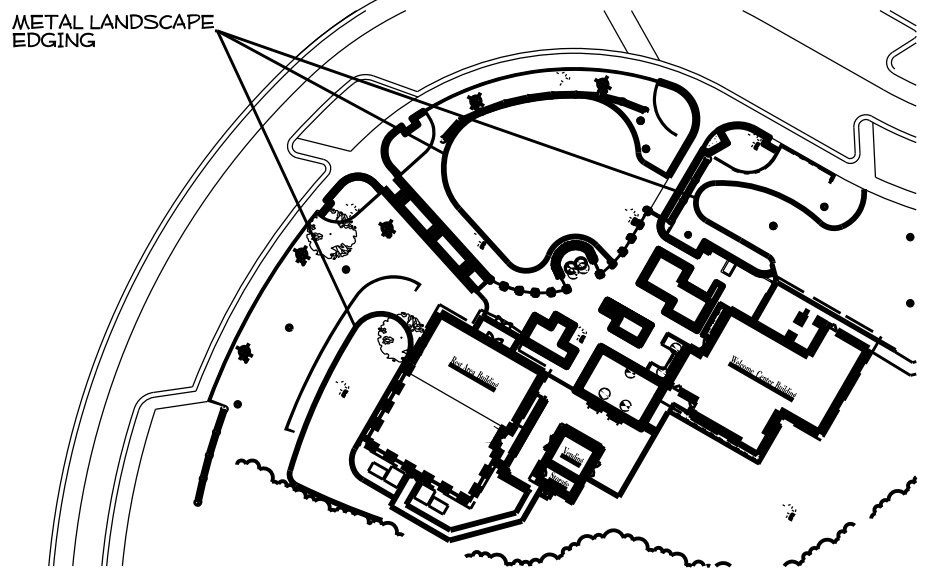
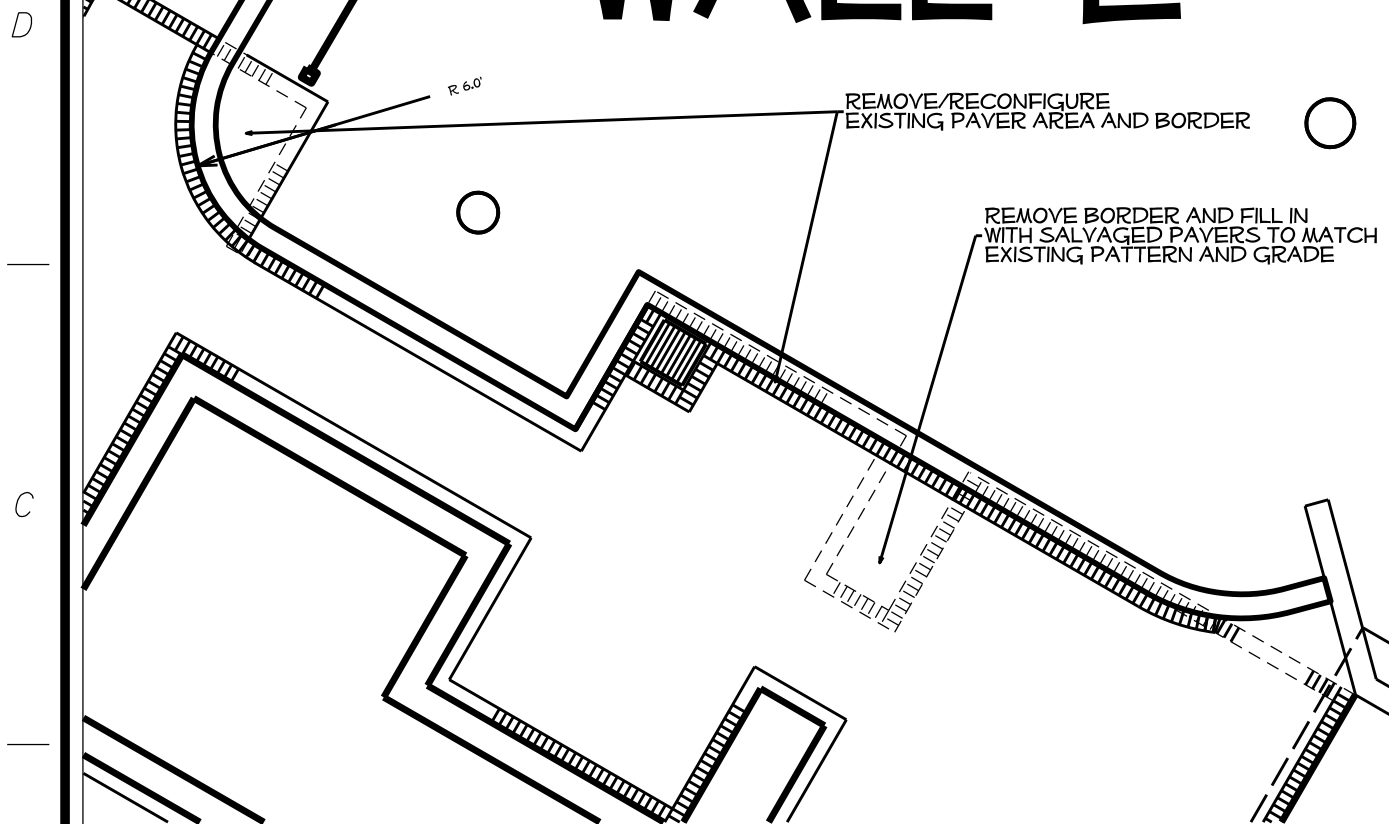

## LANDSCAPE METAL EDGING

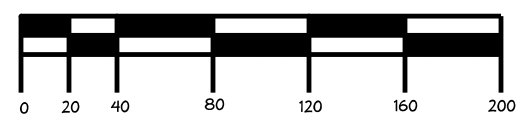

## PAYER AREA MODIFICATIONS

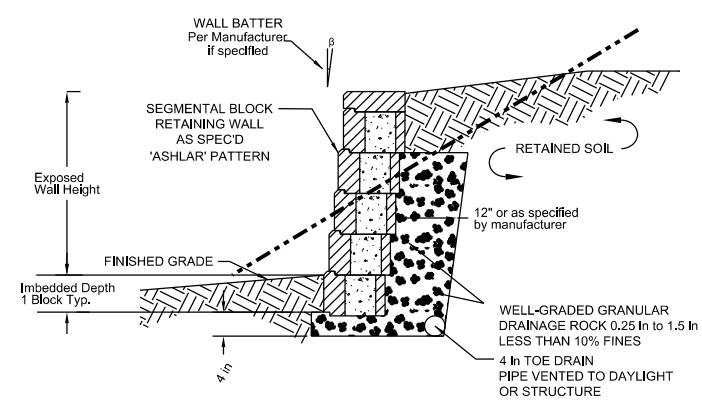
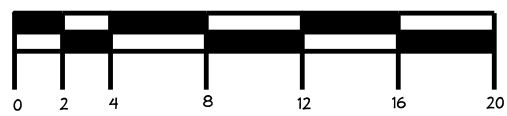

\* STEP WALL AS REQUIRED TO MAINTAIN EXPOSED HEIGHT PER SCHEDULE EXCEPT AT WALL RETURNS INTO EXISTING GRADE

GRAVITY RETAINING WALL (TYP)  
WALLS 'A', 'B', 'C', 'D', 'G', 'H' AND 'J' NTS

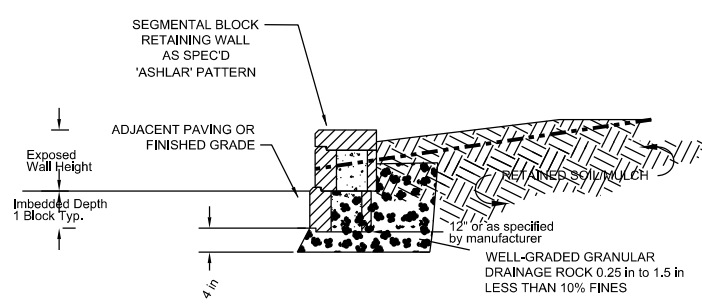

\* STEP WALL AS REQUIRED TO MAINTAIN 6-14' EXPOSED HEIGHT

GRAVITY CURB WALL (TYP)  
WALLS 'E', 'F', 'K', AND 'L' NTS

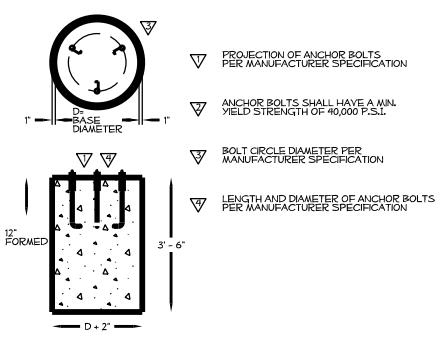

## FOUNDATION FOR POST TOP LIGHT

## SEGMENTAL BLOCK WALL DETAILS (MAY VARY WITH MANUFACTURER)



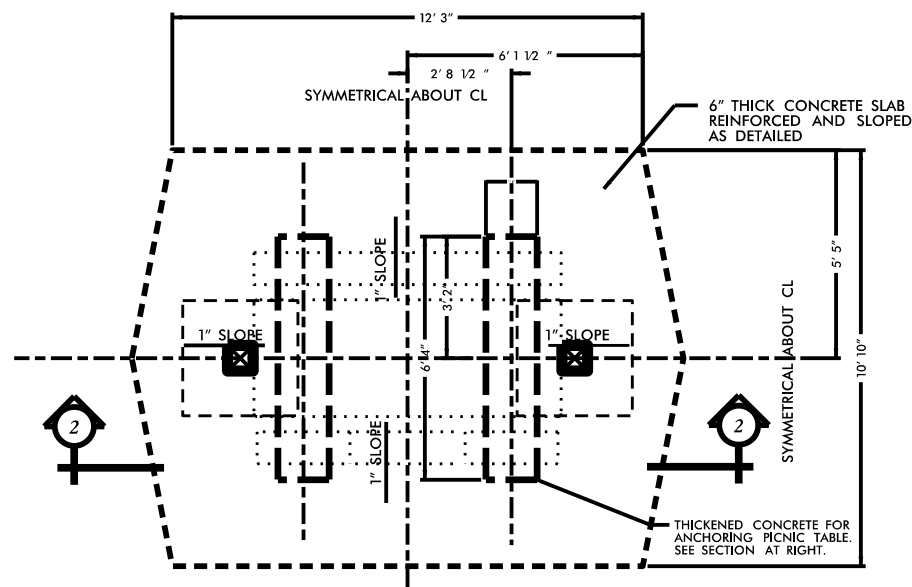

**1 CONCRETE PAD PLAN**  
1/2" = 1' 0"

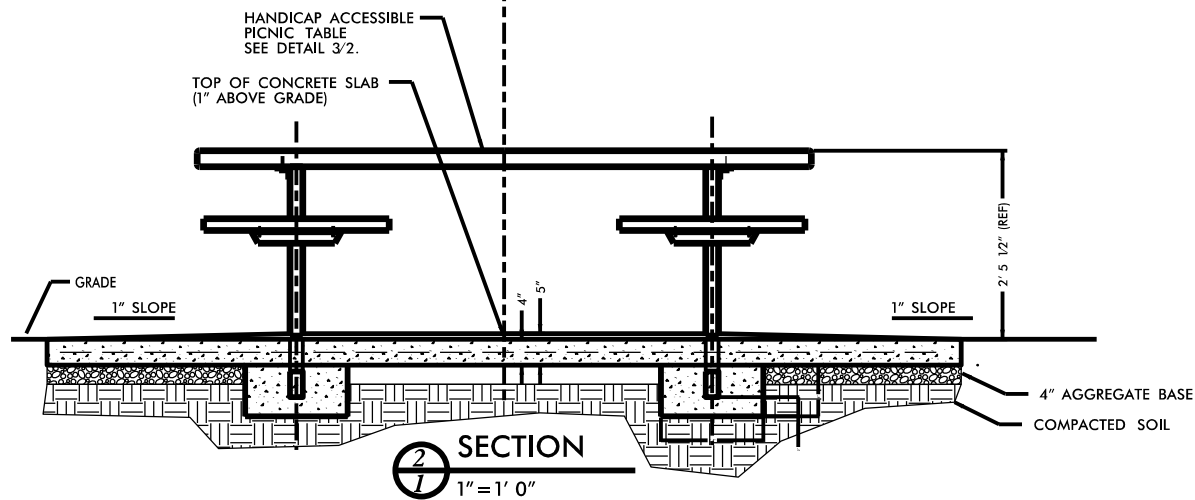

**2 SECTION**  
1" = 1' 0"

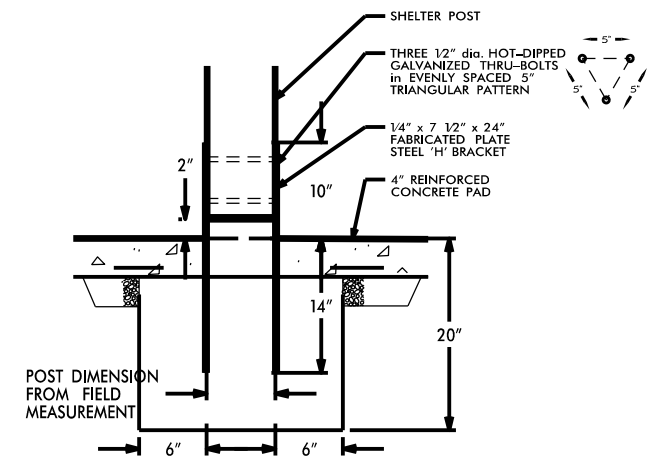

**5 'H' BRACKET POST ANCHOR for RELOCATED PICNIC SHELTER**  
N.T.S. 2 Required

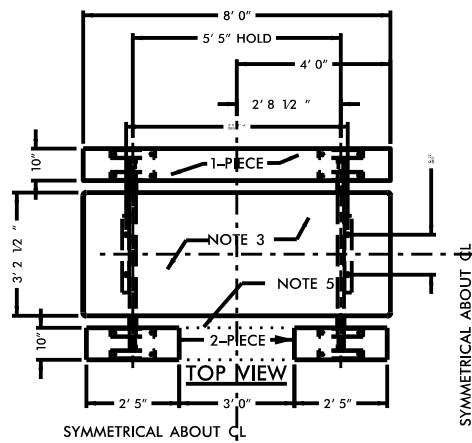

**2 PICNIC TABLE**  
1/2" = 1' 0"

- NOTE:  
 1) TUBULAR PICNIC TABLE FRAME SHALL BE 2" x 4" x 1/4" RECTANGULAR STEEL TUBING.  
 2) MITER ALL CORNERS, CONTINUOUS WELD ALL CONNECTIONS AND GRIND SMOOTH. (TYP. ALL TUBULAR FRAMING AND STEEL ANGLES).  
 3) PICNIC TABLETOP SHALL BE PRECAST TERRAZZO. SPECIFICATION SHALL BE THE SAME AS (OR EQUAL TO) SAMPLE #061217-1, AS SUPPLIED BY PRECAST TERRAZZO ENTERPRISES, INC., 1107 N. NEW HOPE ROAD, RALEIGH, NC, 27610. TELE: 800.849.8849/919.231-6200, EXT 105  
 5) NON-HANDICAP TABLE REQUIRES ONE (1) PIECE SEAT ON BOTH SIDES OF TABLE. HANDICAP TABLE REQUIRES TWO (2) PIECE SEAT ON ONE SIDE OF TABLE. ORIENT 2-PIECE SEAT TOWARDS ACCESS.

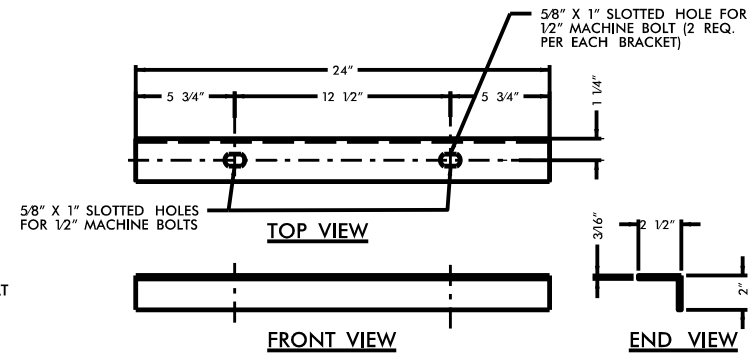

**3 TABLETOP BRACKET - 2 REQ.**  
NO SCALE

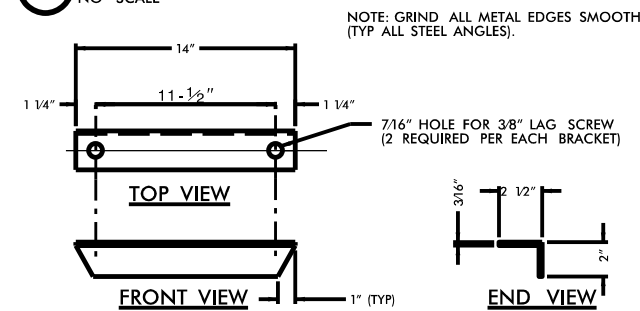

**4 SEAT BRACKET - 8 REQ.**  
NO SCALE

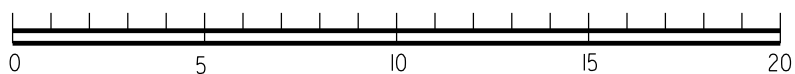
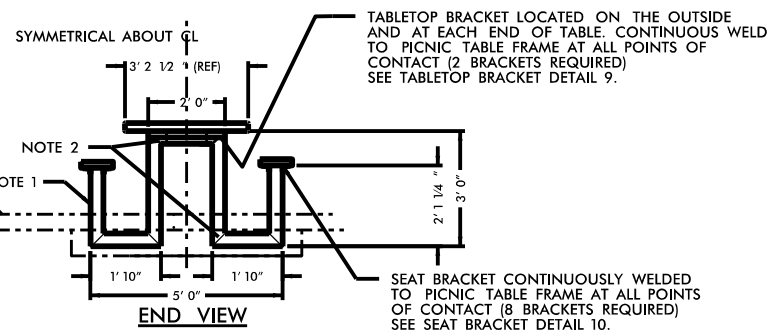

USE DETAIL FOR REFERENCE TO RELOCATE EXISTING PICNIC SHELTER

S:\PROJECTS\3711.3.15\3711.3.15.DWG



NCDOT - ROADSIDE ENVIRONMENTAL UNIT  
 LANDSCAPE DESIGN & DEVELOPMENT  
 1557 MAIL SERVICE CENTER RALEIGH NC 27699-1557  
 PH: 919-707-2920 FAX: 919-733-9810  
 HTTP://WWW.NCDOT.ORG/DOH/OPERATIONS/DP\_CHIEF\_ENG/ROADSIDE/

I- 77 SURRY COUNTY  
 WELCOME CENTER  
 LANDSCAPE RENOVATION  
 PROJECT #: 3711.3.15

REV ENGINEER

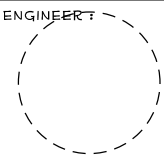

PREL DESIGN DATE:	DECEMBER 2011
CHECKED BY & DATE:	
FINAL DESIGN DATE:	DECEMBER 2011

DETAILS  
 PICNIC TABLE



T.I.P. #	WBS # 3711.3.15
FED I.D. #	
SHEET NO:	TOTAL SHEET NO:
LD-14	14